



## Center Center Module

Center Center is a modular system from String Furniture made entirely of sheet metal in a constructivist hole pattern. The system consists of modules that can be configured almost infinitely without restrictions, vertically and horizontally. The key to this flexibility is a 'special fitting', an ingeniously simple way to connect units, accessories and more - however you choose to place them!

Every module is made to order to fit your demands and plans. If you choose a plain module, you only need to make one decision – if you want shelf brackets, or not. Simply choose from the two options below and then the size of the actual module itself.

### About the designers – Form Us With Love

Form Us With Love is an international design studio founded in 2005, based in Stockholm. The founders, Jonas Pettersson and John Löfgren, started the studio with the central idea that design should not only improve people's lives, but also be mindful of the environment. At the studio's core lies a process that blends traditional hands-on creative practices with a lean application, that evolve with the ever-changing needs of real people in a hyper-connected, digitalised world.

### Product dimensions

W: 60 cm D: 40 cm H: 60 cm  
 W: 40 cm D: 40 cm H: 60 cm  
 W: 60 cm D: 40 cm H: 40 cm  
 W: 40 cm D: 40 cm H: 40 cm  
 W: 30 cm D: 40 cm H: 40 cm  
 W: 40 cm D: 40 cm H: 30 cm

### Package dimensions

Center Center system will be transported on a pallet protected by a well container.

### Weight recommendation - Module

W: 60 cm D: 40 cm H: 60 cm - max 72 kg evenly spread  
 W: 40 cm D: 40 cm H: 60 cm - max 72 kg evenly spread  
 W: 60 cm D: 40 cm H: 40 cm - max 36 kg evenly spread  
 W: 40 cm D: 40 cm H: 40 cm - max 36 kg evenly spread  
 W: 30 cm D: 40 cm H: 40 cm - max 36 kg evenly spread  
 W: 40 cm D: 40 cm H: 30 cm - max 36 kg evenly spread

### Weight recommendation - Shelf

60cm wide shelf: max 17 kg evenly spread  
 40cm wide shelf: max 11 kg evenly spread  
 30cm wide shelf: max 8 kg evenly spread

### Materials and colours

Powder coated steel in gloss 30.

### Production

Made in Sweden.







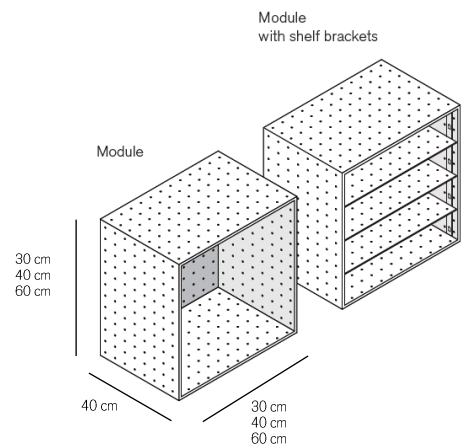

### Sustainability

Center Center Module is made from steel with 20% recycled material. It can be recycled.

### Care and maintenance

Wipe the surface with a damp cloth. Then rub dry with a clean, dry cloth. Remove stains with detergents that do not contain abrasives. Never use steel wool.



	Black, RAL K7 9005		Sulphur Yellow, RAL 1016
	White, RAL K7 9003		Chrome green, RAL 6020
	Light grey, RAL K7 7047		Oyster white, RAL 1013
	Pompeii Red, RAL D2 040 50 70		Ultramarine, RAL 5002
	Custom colour		



## Center Center Module with Door

Center Center is a modular system from String Furniture made entirely of sheet metal in a constructivist hole pattern. The system consists of modules that can be configured almost infinitely without restrictions, vertically and horizontally. The key to this flexibility is a 'special fitting', an ingeniously simple way to connect units, accessories and more - however you choose to place them!

Every module is made to order to fit your demands and plans. When you choose a module with a door, you need to make a couple of decisions: the direction you want the door to open, if you want shelves inside the modules and if it should have a push-open or a U-handle. Simply choose from the different options below and then choose the size of the actual module itself.

### About the designers – Form Us With Love

Form Us With Love is an international design studio founded in 2005, based in Stockholm. The founders, Jonas Pettersson and John Löfgren, started the studio with the central idea that design should not only improve people's lives, but also be mindful of the environment. At the studio's core lies a process that blends traditional hands-on creative practices with a lean application, that evolve with the ever-changing needs of real people in a hyper-connected, digitalised world.

### Product dimensions

W: 60 cm D: 40 cm H: 60 cm  
 W: 40 cm D: 40 cm H: 60 cm  
 W: 60 cm D: 40 cm H: 40 cm  
 W: 40 cm D: 40 cm H: 40 cm  
 W: 30 cm D: 40 cm H: 40 cm  
 W: 40 cm D: 40 cm H: 30 cm

### Package dimensions

Center Center system will be transported on a pallet protected by a well container.

### Weight recommendation - Module

W: 60 cm D: 40 cm H: 60 cm - max 72 kg evenly spread  
 W: 40 cm D: 40 cm H: 60 cm - max 72 kg evenly spread  
 W: 60 cm D: 40 cm H: 40 cm - max 36 kg evenly spread  
 W: 40 cm D: 40 cm H: 40 cm - max 36 kg evenly spread  
 W: 30 cm D: 40 cm H: 40 cm - max 36 kg evenly spread  
 W: 40 cm D: 40 cm H: 30 cm - max 36 kg evenly spread

### Weight recommendation - Shelf

60cm wide shelf: max 17 kg evenly spread  
 40cm wide shelf: max 11 kg evenly spread  
 30cm wide shelf: max 8 kg evenly spread

### Materials and colours

Powder coated steel in gloss 30.

### Production

Made in Sweden.







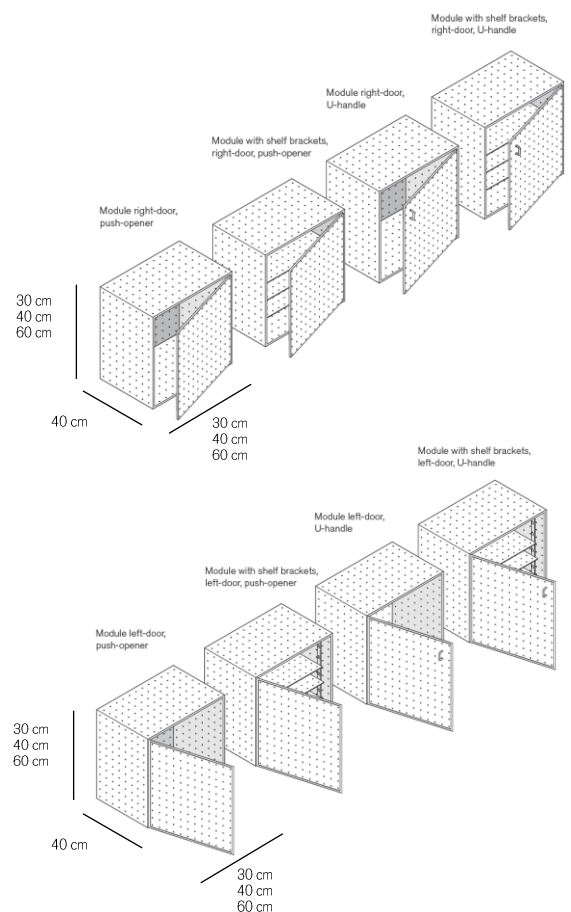

### Sustainability

Center Center Module with door is made from steel with 20% recycled material. It can be recycled.

### Care and maintenance

Wipe the surface with a damp cloth. Then rub dry with a clean, dry cloth. Remove stains with detergents that do not contain abrasives. Never use steel wool.



	Black, RAL K7 9005		Sulphur Yellow, RAL 1016
	White, RAL K7 9003		Chrome green, RAL 6020
	Light grey, RAL K7 7047		Oyster white, RAL 1013
	Pompeii Red, RAL D2 040 50 70		Ultramarine, RAL 5002
	Custom colour		



## Center Center Open Module

Center Center is a modular system from String Furniture made entirely of sheet metal in a constructivist hole pattern. The system consists of modules that can be configured almost infinitely without restrictions, vertically and horizontally. The key to this flexibility is a 'special fitting', an ingeniously simple way to connect units, accessories and more - however you choose to place them!

Every module is made to order to fit your demands and plans. If you choose an open module, you only need to make one decision – if you want shelf brackets, or not. Simply choose from the two options below and then the size of the actual module itself.

### About the designers – Form Us With Love

Form Us With Love is an international design studio founded in 2005, based in Stockholm. The founders, Jonas Pettersson and John Löfgren, started the studio with the central idea that design should not only improve people's lives, but also be mindful of the environment. At the studio's core lies a process that blends traditional hands-on creative practices with a lean application, that evolve with the ever-changing needs of real people in a hyper-connected, digitalised world.

### Product dimensions

W: 60 cm D: 40 cm H: 60 cm  
 W: 40 cm D: 40 cm H: 60 cm  
 W: 60 cm D: 40 cm H: 40 cm  
 W: 40 cm D: 40 cm H: 40 cm  
 W: 30 cm D: 40 cm H: 40 cm  
 W: 40 cm D: 40 cm H: 30 cm

### Package dimensions

Center Center system will be transported on a pallet protected by a well container.

### Weight recommendation - Module

W: 60 cm D: 40 cm H: 60 cm - max 72 kg evenly spread  
 W: 40 cm D: 40 cm H: 60 cm - max 72 kg evenly spread  
 W: 60 cm D: 40 cm H: 40 cm - max 36 kg evenly spread  
 W: 40 cm D: 40 cm H: 40 cm - max 36 kg evenly spread  
 W: 30 cm D: 40 cm H: 40 cm - max 36 kg evenly spread  
 W: 40 cm D: 40 cm H: 30 cm max 36 kg evenly spread

### Weight recommendation - Shelf

60cm wide shelf: max 17 kg evenly spread  
 40cm wide shelf: max 11 kg evenly spread  
 30cm wide shelf: max 8 kg evenly spread

### Materials and colours

Powder coated steel in gloss 30.

### Production

Made in Sweden.







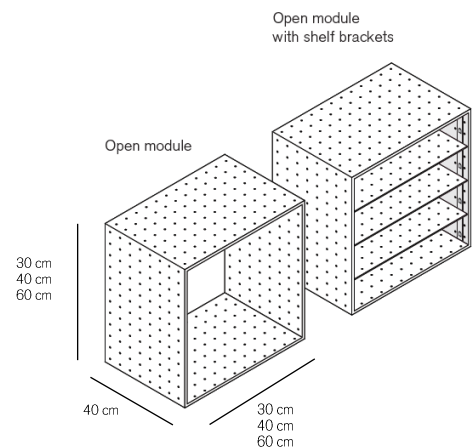

### Sustainability

Center Center Open Module is made from steel with 20% recycled material. It can be recycled.

### Care and maintenance

Wipe the surface with a damp cloth. Then rub dry with a clean, dry cloth. Remove stains with detergents that do not contain abrasives. Never use steel wool.



	Black, RAL K7 9005		Sulphur Yellow, RAL 1016
	White, RAL K7 9003		Chrome green, RAL 6020
	Light grey, RAL K7 7047		Oyster white, RAL 1013
	Pompeii Red, RAL D2 040 50 70		Ultramarine, RAL 5002
	Custom colour		



## Center Center Features

Center Center is a modular system from String Furniture made entirely of sheet metal in a constructivist hole pattern. The system consists of modules that can be configured almost infinitely without restrictions, vertically and horizontally. The key to this flexibility is a 'special fitting', an ingeniously simple way to connect units, accessories and more - however you choose to place them!

There is a host of accessories to enhance the Center Center system, all designed to fit with the hole pattern in the modules. Avoid placing the modules directly on the ground - choose from rubber pads, legs or connecting leg, wheels with or without stopper.

### About the designers – Form Us With Love

Form Us With Love is an international design studio founded in 2005, based in Stockholm. The founders, Jonas Pettersson and John Löfgren, started the studio with the central idea that design should not only improve people's lives, but also be mindful of the environment. At the studio's core lies a process that blends traditional hands-on creative practices with a lean application, that evolve with the ever-changing needs of real people in a hyper-connected, digitalised world.

### Product dimensions

Rubber pad - Dia: 1,9 cm x H: 0,4 cm  
 Leg and connecting leg - H: 12,5 cm  
 Wheel and connecting wheel - H: 7 cm

### Package dimensions

Center Center system will be transported on a pallet protected by a well container.

### Weight recommendation

Module recommendations.

### Materials and colours

Rubber pad in rubber.  
 Leg and connecting leg powder coated steel in gloss 30.  
 Wheel in steel with zinc coating and black TPE.

### Production

Rubber pad made in Great Britain.  
 Leg and connecting leg made in Sweden.  
 Wheel made in China and Sweden.

### Sustainability







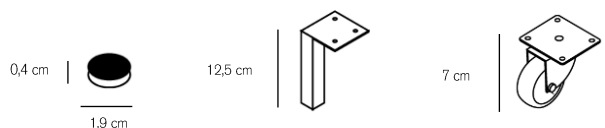
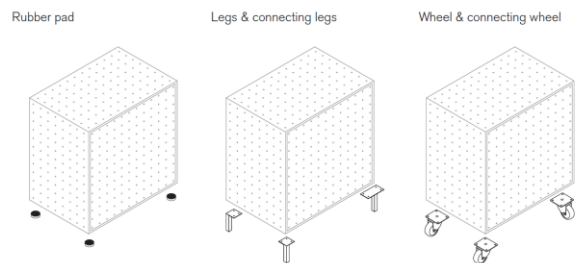

The wheel is made from steel, which can be recycled.  
 The leg is made from 20% recycled steel and can be recycled.

### Care and maintenance

Wipe the surface with a damp cloth. Then rub dry with a clean, dry cloth. Remove stains with detergents that do not contain abrasives. Never use steel wool.



### Leg and connecting leg colours:

- |   |  |
|---|--|
|  Black, RAL K7 9005            |  Sulphur Yellow, RAL 1016 |
|  White, RAL K7 9003            |  Chrome green, RAL 6020   |
|  Light grey, RAL K7 7047       |  Oyster white, RAL 1013   |
|  Pompeii Red, RAL D2 040 50 70 |  Ultramarine, RAL 5002    |
|  Custom colour                 |  |

### Wheel colours:

-  Zinc and black TPE

### Rubber pad colours:

-  Black



## Center Center External shelf

Center Center is a modular system from String Furniture made entirely of sheet metal in a constructivist hole pattern. The system consists of modules that can be configured almost infinitely without restrictions, vertically and horizontally. The key to this flexibility is a 'special fitting', an ingeniously simple way to connect units, accessories and more - however you choose to place them!

There is a host of accessories to enhance the Center Center system, all designed to fit with the hole pattern in the modules. The external shelves can be mounted and secured with the 'special fitting' on the side of the modules

### About the designers – Form Us With Love

Form Us With Love is an international design studio founded in 2005, based in Stockholm. The founders, Jonas Pettersson and John Löfgren, started the studio with the central idea that design should not only improve people's lives, but also be mindful of the environment. At the studio's core lies a process that blends traditional hands-on creative practices with a lean application, that evolve with the ever-changing needs of real people in a hyper-connected, digitalised world.

### Product dimensions

W: 40 cm D: 20 cm H: 20 cm

### Package dimensions

Center Center system will be transported on a pallet protected by a well container.

### Weight recommendation

6kg evenly spread.

### Materials and colours

Powder coated steel in gloss 30.

### Production

Made in Sweden.







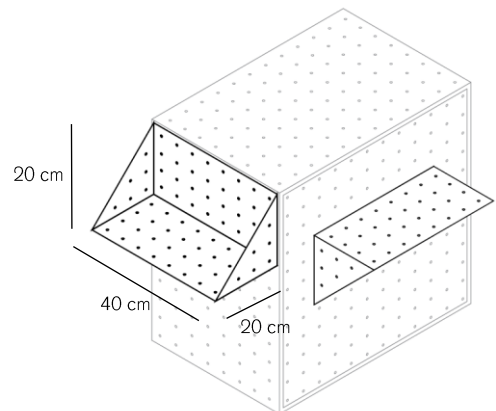

### Sustainability

Center Center External shelf is made from steel with 20% recycled material. It can be recycled.

### Care and maintenance

Wipe the surface with a damp cloth. Then rub dry with a clean, dry cloth. Remove stains with detergents that do not contain abrasives. Never use steel wool.



	Black, RAL K7 9005		Sulphur Yellow, RAL 1016
	White, RAL K7 9003		Chrome green, RAL 6020
	Light grey, RAL K7 7047		Oyster white, RAL 1013
	Pompeii Red, RAL D2 040 50 70		Ultramarine, RAL 5002
	Custom colour		





## Center Center Tray

Center Center is a modular system from String Furniture made entirely of sheet metal in a constructivist hole pattern. The system consists of modules that can be configurated almost infinitely without restrictions, vertically and horizontally. The key to this flexibility is a 'special fitting', an ingeniously simple way to connect units, accessories and more - however you choose to place them!

There is a host of accessories to enhance the Center Center system, all designed to fit with the hole pattern in the modules. The trays come in three sizes and can be mounted and secured with the 'special fitting' either on top or on the side of the modules

### About the designers – Form Us With Love

Form Us With Love is an international design studio founded in 2005, based in Stockholm. The founders, Jonas Pettersson and John Löfgren, started the studio with the central idea that design should not only improve people's lives, but also be mindful of the environment. At the studio's core lies a process that blends traditional hands-on creative practices with a lean application, that evolve with the ever-changing needs of real people in a hyper-connected, digitalised world.

### Product dimensions

W: 30 cm D: 40 cm H: 20 cm

W: 40 cm D: 40 cm H: 20 cm

W: 60 cm D: 40 cm H: 20 cm

### Package dimensions

Center Center system will be transported on a pallet protected by a well container.

### Weight recommendation

6kg evenly spread.

### Materials and colours

Powder coated steel in gloss 30.

### Production

Made in Sweden.







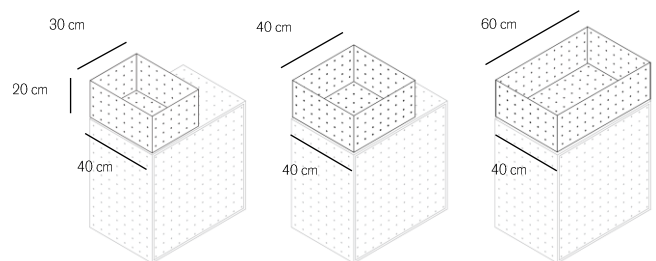

### Sustainability

Center Center Tray is made from steel with 20% recycled material. It can be recycled.

### Care and maintenance

Wipe the surface with a damp cloth. Then rub dry with a clean, dry cloth. Remove stains with detergents that do not contain abrasives. Never use steel wool.



	Black, RAL K7 9005		Sulphur Yellow, RAL 1016
	White, RAL K7 9003		Chrome green, RAL 6020
	Light grey, RAL K7 7047		Oyster white, RAL 1013
	Pompeii Red, RAL D2 040 50 70		Ultramarine, RAL 5002
	Custom colour		



## Center Center U-Handle

Center Center is a modular system from String Furniture made entirely of sheet metal in a constructivist hole pattern. The system consists of modules that can be configured almost infinitely without restrictions, vertically and horizontally. The key to this flexibility is a 'special fitting', an ingeniously simple way to connect units, accessories and more - however you choose to place them!

There is a host of accessories to enhance the Center Center system, all designed to fit with the hole pattern in the modules.

### About the designers – Form Us With Love

Form Us With Love is an international design studio founded in 2005, based in Stockholm. The founders, Jonas Pettersson and John Löfgren, started the studio with the central idea that design should not only improve people's lives, but also be mindful of the environment. At the studio's core lies a process that blends traditional hands-on creative practices with a lean application, that evolve with the ever-changing needs of real people in a hyper-connected, digitalised world.

### Product dimensions

W: 5,8 cm D: 0,8 cm H: 3,6 cm

### Package dimensions

Center Center system will be transported on a pallet protected by a well container.

### Weight recommendation

N/A

### Materials and colours

Powder coated steel in gloss 30.

### Production

Made in Sweden.







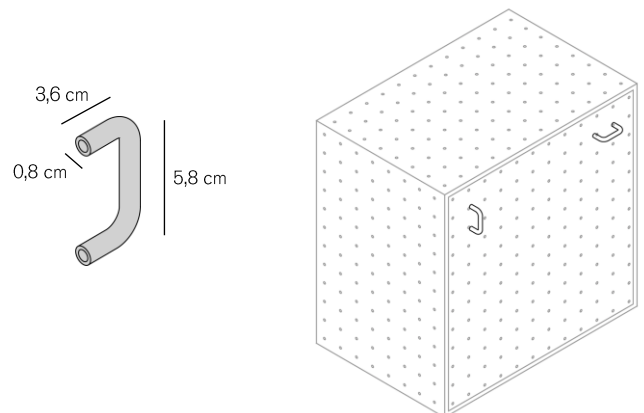

### Sustainability

Center Center U-Handle is made from virgin steel, which can be recycled.

### Care and maintenance

Wipe the surface with a damp cloth. Then rub dry with a clean, dry cloth. Remove stains with detergents that do not contain abrasives. Never use steel wool.



	Black, RAL K7 9005		Sulphur Yellow, RAL 1016
	White, RAL K7 9003		Chrome green, RAL 6020
	Light grey, RAL K7 7047		Oyster white, RAL 1013
	Pompeii Red, RAL D2 040 50 70		Ultramarine, RAL 5002
	Custom colour		



## Center Center Hook

Center Center is a modular system from String Furniture made entirely of sheet metal in a constructivist hole pattern. The system consists of modules that can be configured almost infinitely without restrictions, vertically and horizontally. The key to this flexibility is a 'special fitting', an ingeniously simple way to connect units, accessories and more - however you choose to place them!

There is a host of accessories to enhance the Center Center system, all designed to fit with the hole pattern in the modules. The hooks make the sides useful.

### About the designers – Form Us With Love

Form Us With Love is an international design studio founded in 2005, based in Stockholm. The founders, Jonas Pettersson and John Löfgren, started the studio with the central idea that design should not only improve people's lives, but also be mindful of the environment. At the studio's core lies a process that blends traditional hands-on creative practices with a lean application, that evolve with the ever-changing needs of real people in a hyper-connected, digitalised world.

### Product dimensions

W: 1,9 cm D: 3,2 cm H: 6,4 cm

### Package dimensions

Center Center system will be transported on a pallet protected by a well container.

### Weight recommendation

2 kg

### Materials and colours

Powder coated steel in gloss 30.

### Production

Made in Sweden.







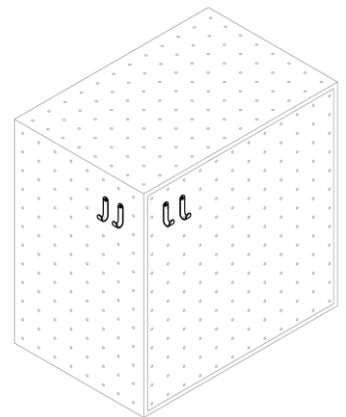
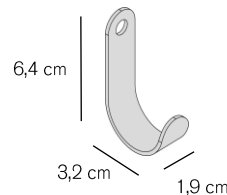

### Sustainability

Center Center Hook is made from steel with 19% recycled material. It can be recycled.

### Care and maintenance

Wipe the surface with a damp cloth. Then rub dry with a clean, dry cloth. Remove stains with detergents that do not contain abrasives. Never use steel wool.



	Black, RAL K7 9005		Sulphur Yellow, RAL 1016
	White, RAL K7 9003		Chrome green, RAL 6020
	Light grey, RAL K7 7047		Oyster white, RAL 1013
	Pompeii Red, RAL D2 040 50 70		Ultramarine, RAL 5002
	Custom colour		





## Center Center Fitting

Center Center is a modular system from String Furniture made entirely of sheet metal in a constructivist hole pattern. The system consists of modules that can be configured almost infinitely without restrictions, vertically and horizontally. The key to this flexibility is a 'special fitting', an ingeniously simple way to connect units, accessories and more - however you choose to place them!

### About the designers – Form Us With Love

Form Us With Love is an international design studio founded in 2005, based in Stockholm. The founders, Jonas Pettersson and John Löfgren, started the studio with the central idea that design should not only improve people's lives, but also be mindful of the environment. At the studio's core lies a process that blends traditional hands-on creative practices with a lean application, that evolve with the ever-changing needs of real people in a hyper-connected, digitalised world.

### Product dimensions

Dia: 1,7 cm D: 1,5 cm

### Package dimensions

Center Center system will be transported on a pallet protected by a well container.

### Weight recommendation

N/A

### Materials and colours

Zinc plated steel.

### Production

Made in Sweden.

### Sustainability

Center Center Fitting is made from steel with 96% recycled material. It can be recycled.

### Care and maintenance

Wipe the surface with a damp cloth. Then rub dry with a clean, dry cloth. Remove stains with detergents that do not contain abrasives. Never use steel wool.

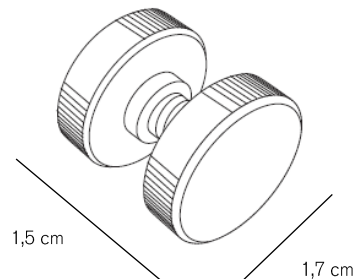

 Zinc plated steel